

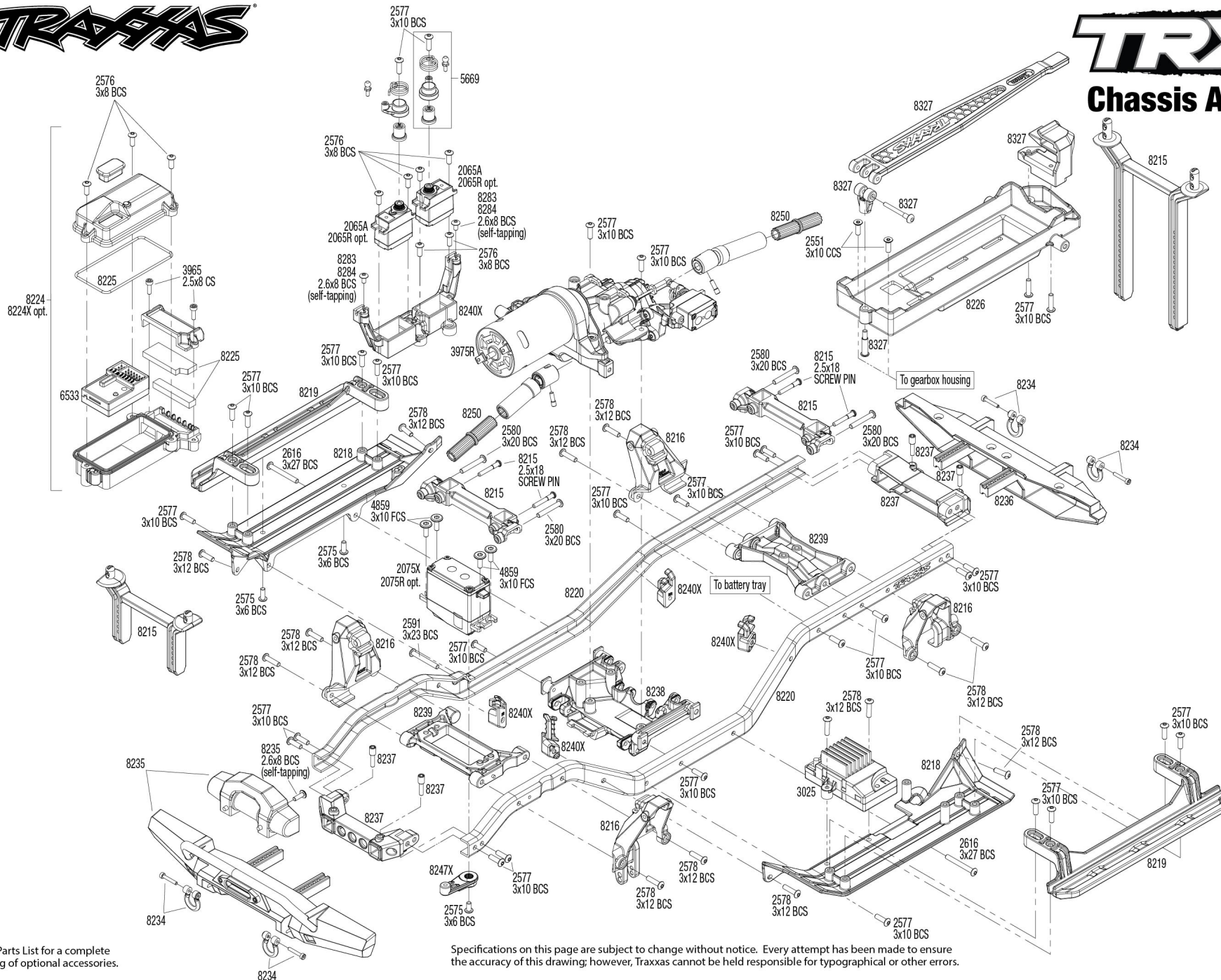

## Chassis Assembly



See Parts List for a complete listing of optional accessories.

Specifications on this page are subject to change without notice. Every attempt has been made to ensure the accuracy of this drawing; however, Traxxas cannot be held responsible for typographical or other errors.

# TRX4<sup>®</sup>

## Front Assembly

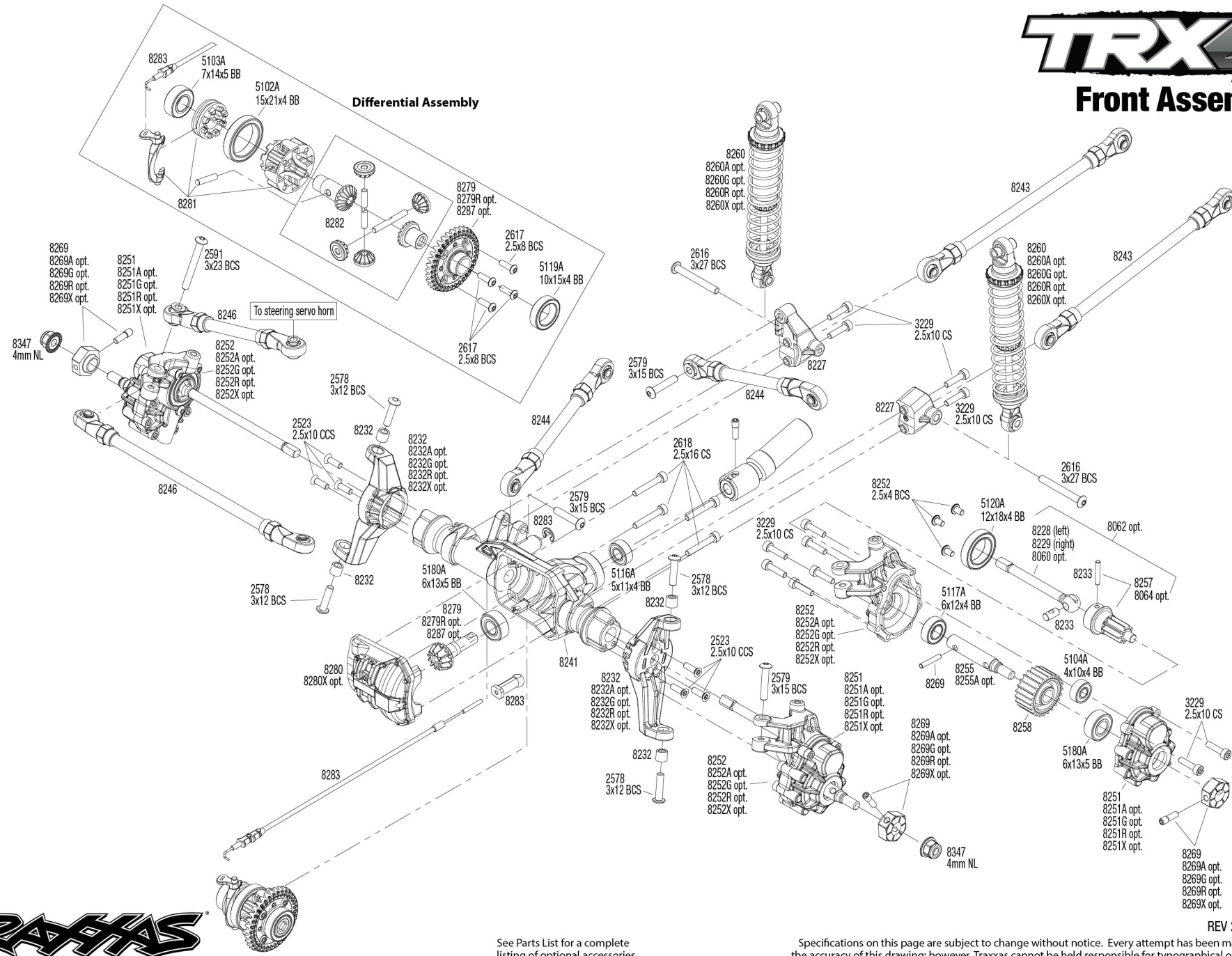

See Parts List for a complete listing of optional accessories.

Specifications on this page are subject to change without notice. Every attempt has been made to ensure the accuracy of this drawing; however, Traxxas cannot be held responsible for typographical or other errors.

REV 210706-R22



## Link Dimensions

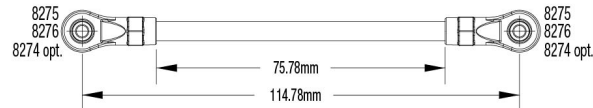

**FRONT LOWER LINK (QTY. 2)**

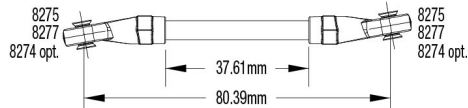

**FRONT UPPER LINK (QTY. 1)**

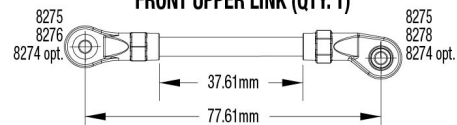

**PANHARD BAR (QTY. 1)**

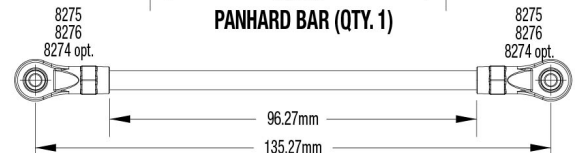

**REAR LOWER LINK (QTY. 2)**

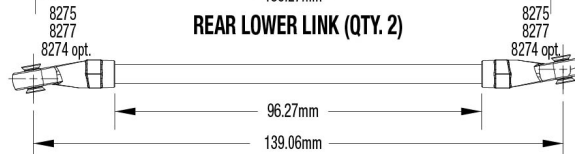

**REAR UPPER LINK (QTY. 2)**

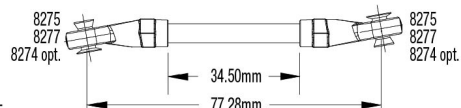

**STEERING LINK (QTY. 1)**

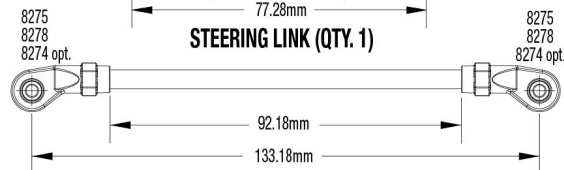

**DRAG LINK (QTY. 1)**

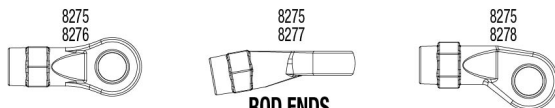

**ROD ENDS**

For standard hollow ball replacement, use part #5349.



## Modular Assembly

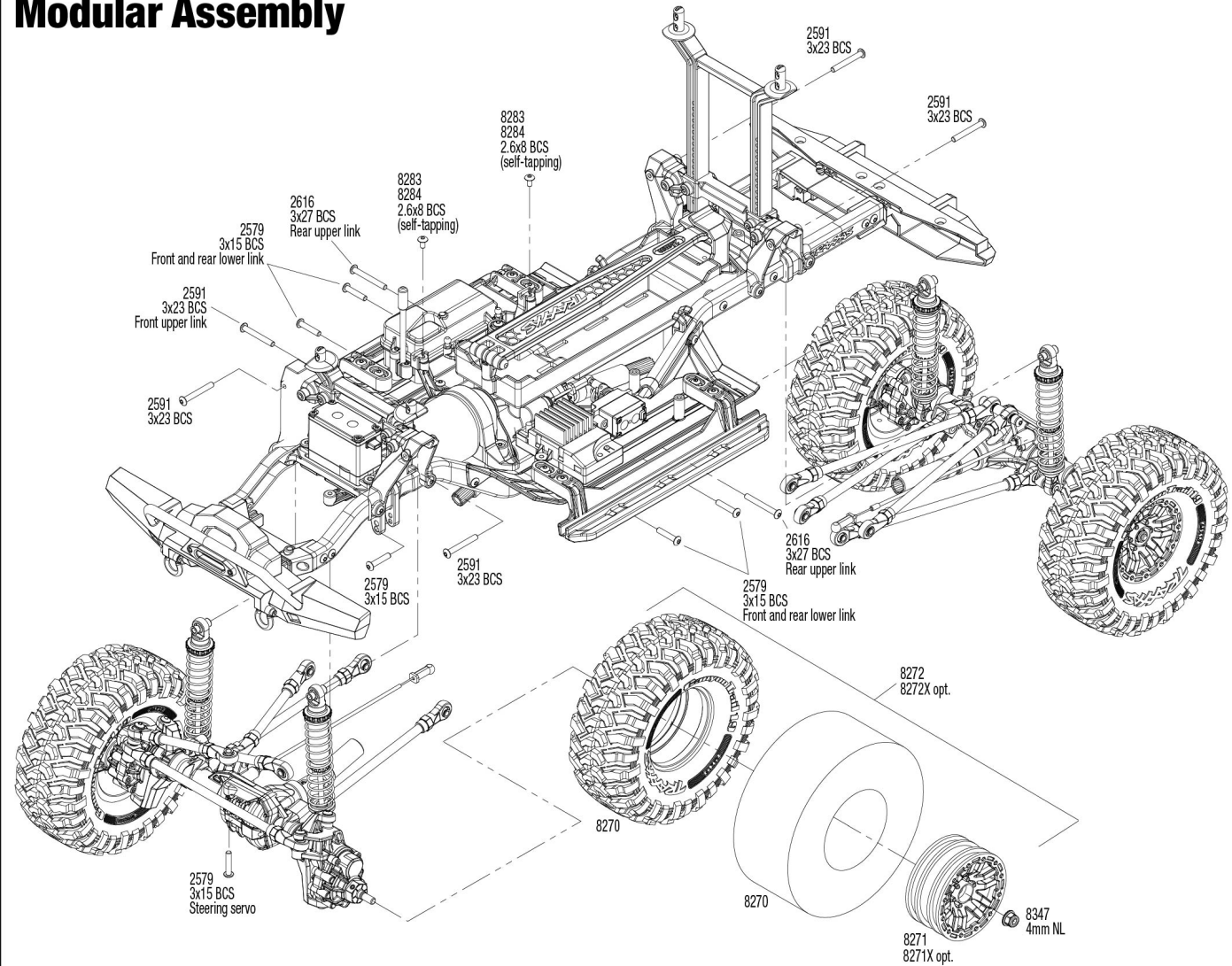

See Parts List for a complete listing of optional accessories.

Specifications on this page are subject to change without notice. Every attempt has been made to ensure the accuracy of this drawing; however, Traxxas cannot be held responsible for typographical or other errors.

## Rear Assembly

### Shock Assembly

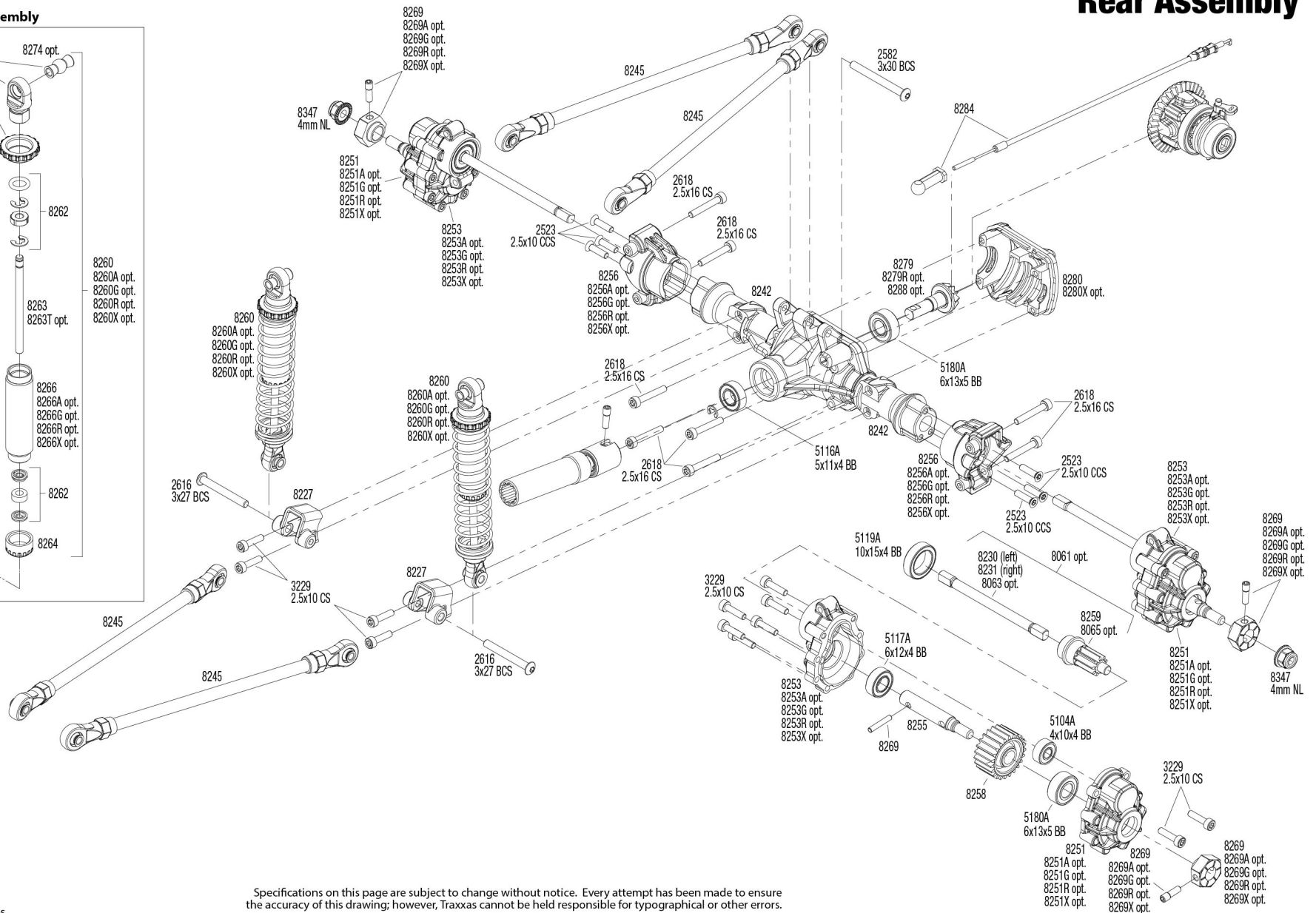
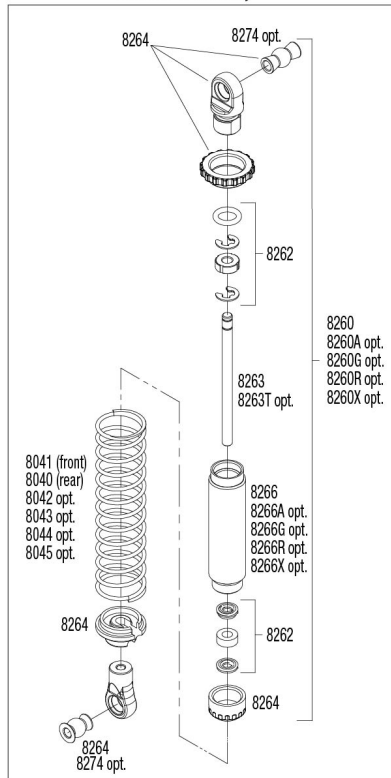

REV 210706-R22

See Parts List for a complete listing of optional accessories.

Specifications on this page are subject to change without notice. Every attempt has been made to ensure the accuracy of this drawing; however, Traxxas cannot be held responsible for typographical or other errors.



### Transmission and Transfer Case Gears

Note the orientation of the gears

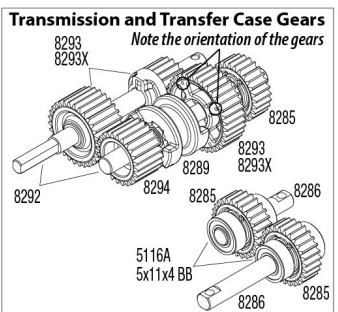

# Transmission Assembly

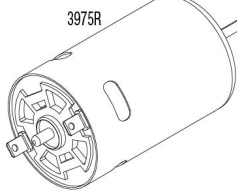
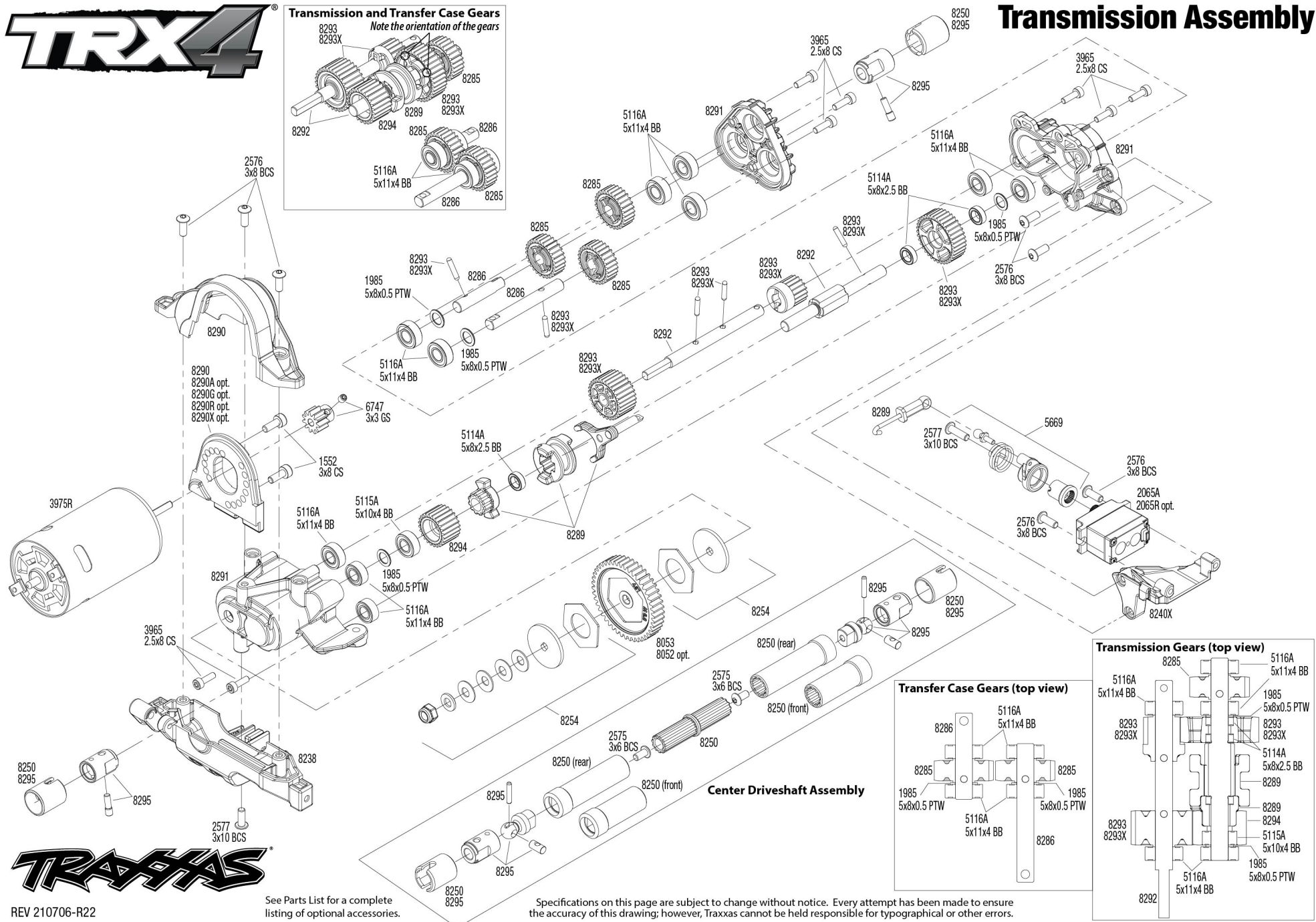

8290  
8290A opt.  
8290G opt.  
8290R opt.  
8290X opt.

6747  
3x3 GS

1552  
3x8 CS

5116A  
5x11x4 BB

5115A  
5x10x4 BB

1985  
5x8x0.5 PTW

5116A  
5x11x4 BB

8294

8291

8290

3965  
2.5x8 CS

2576  
3x8 BCS

2065A  
2065R opt.

2576  
3x8 BCS

8240X

8290

8290

8290

8290

8290

8290

8290

8290

8290

8290



REV 210706-R22

See Parts List for a complete listing of optional accessories.

Specifications on this page are subject to change without notice. Every attempt has been made to ensure the accuracy of this drawing; however, Traxxas cannot be held responsible for typographical or other errors.

### Transfer Case Gears (top view)

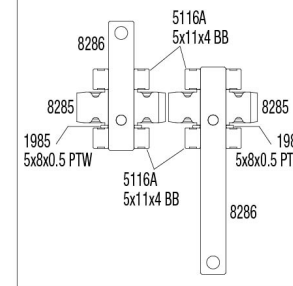

### Transmission Gears (top view)

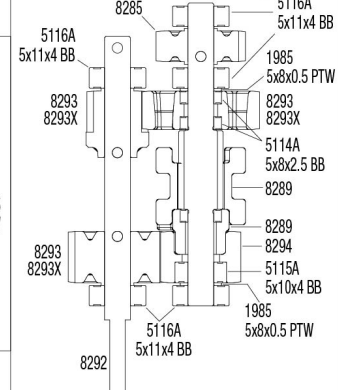

### Center Driveshaft Assembly

